

# HBW01-M

## Mounting Module



### HBW01-M

- Self-aligning construction
- Easy load cell access
- Lift-off protection
- Compatible with HBW01 loadcell

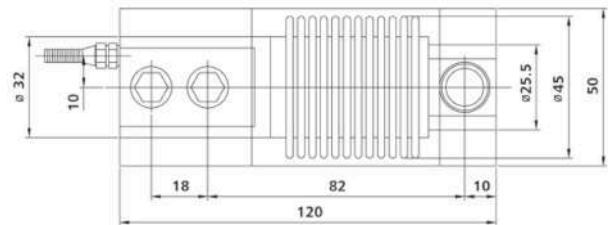
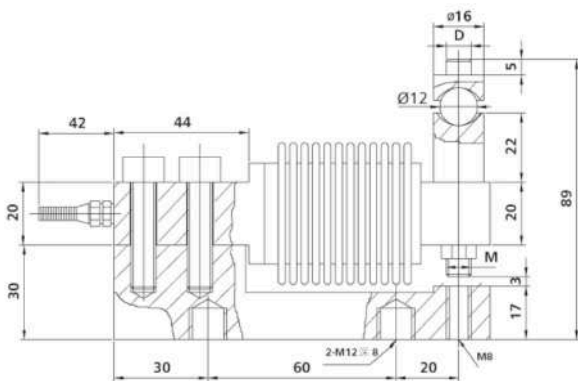
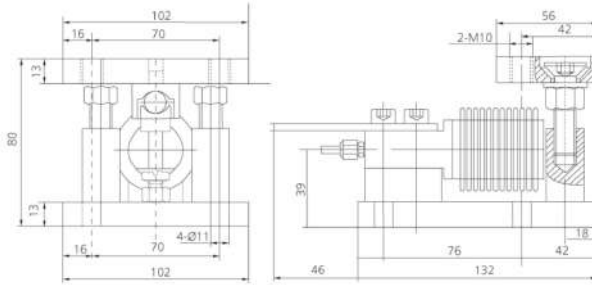
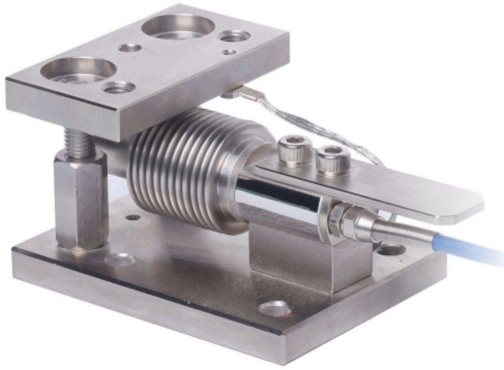

### Main Dimensions

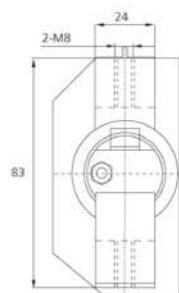
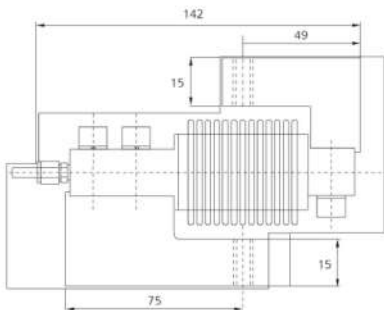

#### (kg) Rated load

5, 10, 20, 30, 40, 50, 75, 100, 150, 200, 250

#### D

ø8

#### M

M8

300, 500

ø10

M10



Radial Install

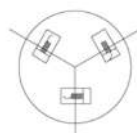

Cutting Install



Rectangle Install

